

Sierra

GMC
TRUCK



Sierra at its finest. Top-level Sierra SLE trim goes the limit in appearance, convenience and comfort. When you consider all that's included in the elegant SLE package, we think you'll agree it makes a perfect partner for pleasure or business trucking.

DISTINCTION STARTS UP FRONT

The high-styled exterior features a chrome-trimmed front-end treatment with black accents, chromed front bumper with bright-edged black rub strip and quad halogen headlamps for impressive night visibility.

All single rear wheel models have black body side moldings with bright trim. Bright wheel opening moldings also are included on single rear wheel Wideside Pickups, except the K-3500 and C6P (8600-lb GVWR) K-2500

Sierra SLE

REGULAR CAB

models which feature wheel opening flares. Other special touches include SLE identification on the body rear pillar and a bright applique with GMC and Sierra identification on the tailgate.

Choose from 10 standard solid paint schemes, including three new colors for '89. Plus, you can select from a variety of available appearance options such as two-tone paint combinations, Rally wheels and chromed rear step bumper.

COMFORT IN THE GRAND STYLE

Step inside and discover full-size Sierra luxury and convenience at its finest. The richly appointed SLE interior offers a choice of Custom Cloth or Custom Vinyl upholstery in Gray, Blue, Beige, Garnet or Saddle. The standard 3-passenger bench seat features a built-in lumbar support when ordered in Custom Cloth. Available bucket seats also can be specified. The color-coordinated trim features full-length carpeting, carpet on cowl kick panels, carpet on cab back panel and padded cloth sun visors with right-hand vanity mirror. Two-tone soft vinyl door trim panels include armrests, assist straps, map pockets and carpeting on the lower portion. A Custom steering wheel also is standard, as is full instrumentation.

SIERRA VALUE PACKAGES

For 1989, Sierra Pickups offer substantial savings when purchased with available Value Packages. See pages 18-19 of this brochure for details.

<i>Index</i>	PAGE
Model Choices	2-11
4x4 Features	12-13
Cab & Chassis	14
Engines	15
Quality Features	16-17
Options/Value Packages	18-19
Exterior Colors	19
Business & Pleasure Features	20
Standard & Available Equipment	21
Technical Information	22-23
Trailer	Back Cover
Owner Benefits	Back Cover

Below: Sierra SLE interior with Custom Cloth seat trim
Center: High-mount instrument cluster features full-gage package.



4-WD Sierra SLE Series K-1500 Wideside Pickup with available Conventional Two-Tone paint and aluminum wheels.

Tires are supplied by various manufacturers.

Above: 4-WD Sierra SLE Series K-1500 Wideside Pickup with 8-foot cargo box.

Big space for people or cargo. Club Coupe is the full-size pickup with the extra-size cab. And, in '89 you can order Club Coupe with either a new 6.5-ft cargo box (available January, 1989) or the longer 8-ft box. Also order it with the available 60/40 split front bench seat and available 3-passenger folding rear seat and this stylish pickup can carry up to six persons, with plenty of leg room for everyone. No wonder so many people are turning to Sierra's Club Coupe model for both business and pleasure transportation.

VERSATILITY WITH UTILITY

When the family's not aboard, the rear seat area provides secure, in-cab storage two ways: The rear seat backrest can be folded down to form a load platform, or the cushion can be folded

up to provide even more space for business cargo, tools, luggage or other gear.

Choose from 2-WD or 4x4 models in the 15-25-3500 Series (new 6.5-ft cargo box models not available in the 3500 Series). There's even a new available 3500 Series 4x4 Heavy Hauler Pickup with dual rear wheels and a 10,000-lb GVWR — an ideal vehicle for pulling big 5th wheel trailers. All this, plus a large selection of gasoline or diesel engines.

BIG ON LUXURY FEATURES

Up front, SLE offers available low-back bucket seats or a 60/40 split bench seat, both of which are designed to allow easy entry to the rear compartment. Both seats require use of the available folding rear seat.

Sierra SLE
CLUB COUPE

Seating can be ordered with Custom Cloth or Custom Vinyl upholstery. Interior color choices are Blue, Saddle or Garnet.

Standard features include full-length, insulated headliner and carpeting, plus carpet trim and insulation on cowl kick panels and the cab back panel — in addition to generous amounts of insulation elsewhere in the cab. A covered tray for jack and tool storage is mounted on the rear compartment floor.

On the outside, this top-level Club Coupe offers the same smart styling touches as SLE Regular Cab models. Swing-out rear quarter windows are available to provide additional comfort for rear seat passengers.

OTHER TRIM SELECTIONS

Club Coupe also is available with mid-level SLX and standard SL trim. These trim packages provide a standard 3-passenger front bench seat with folding backrest which can be replaced with an available 60/40 split bench seat or bucket seats (SLX only) that require use of the available folding rear seat. Without the rear seat, SL and SLX models have 40.5 cubic feet of storage space behind the standard front bench seat. See pages 8-11 for further details.



Sierra SLE Club Coupe interior with front and rear seating trimmed in Custom Vinyl



2-WD Sierra SLE Series C-1500 Club Coupe Widebody Pickup shown with new 6.5-ft cargo box (available January, 1989). Widebody Pickups with an 8-ft box also available.



Sierra SLE Sportside Pickup interior with available bucket seats trimmed in Custom Cloth (also shown with available center console)

Cargo box side steps and available rear step bumper facilitate loading and unloading of the Sportside Pickup.

Sierra SPORTSIDE

A modern classic, Sportside is an attractive blend of contemporary Sierra styling and the traditional looks of a pickup with rear fenders. And it's built just as tough as any other GMC Truck pickup. So if you're looking for a truck that can work hard, and look extra sharp doing it, Sportside is for you.

Sportside is a short wheelbase pickup with 6.5-foot cargo box, and it is available only in the C/K-1500 Series as a Regular Cab model. It offers a maximum GVWR of 5600 lb, which

means you can pack an impressive payload aboard.

UNIQUE CARGO BOX DESIGN

Cargo box outer side panels with smoothly contoured fenders are made of tough, fiberglass-reinforced plastic. Fore and aft access steps are integrated with the side panels. Steel reinforcements add to panel rigidity.

The all-steel, welded inner shell of the box consists of side panels, front-end panel and platform. Two-side galvanized steel is used for all major panels for protection from corrosion, including the steel tailgate which has double-wall construction and a single-lever latch that's easy to operate. The box is roomy enough to carry 4-foot wide items flat on the floor between the side panels.

TAILOR IT TO YOUR TASTE

Sportside can be ordered with SL, SLX or SLE trim. You can also choose standard solid color exterior paint or available Conventional Two-Tone paint. Or dress it up even more by specifying available wheel trim covers or sporty aluminum, rally or styled (2-WD only) wheels.

POWER FOR WORK OR SPORT

The standard Sportside powerplant is a gutsy 4.3 Liter Vortec V6 rated at 160 SAE net horsepower at 4000 RPM. If you'd like more muscle under the hood, specify a big 5.0 or 5.7 Liter V8. All engines are equipped with Electronic Fuel Injection. Heavy-duty chassis options are available to help you equip Sportside for your brand of work or play.



4x4 Sierra SLE Series K-1500 Sportside Pickup shown with available equipment. Tires are supplied by various manufacturers.

Sierra SLX

AVAILABLE REGULAR CAB AND CLUB COUPE MODELS

Street-smart, job tough. Mid-level SLX trim is a step up from standard SL trim in both exterior styling and interior comfort.

The exterior is distinguished by black body side moldings on single rear wheel models, black wheel opening moldings on single rear wheel Wideside Pickups (except C6P K-2500 and K-3500 models which have wheel opening flares) and a chrome front bumper with black protective strip. A color-coordinated decal with GMC letters decorates the tailgate.

HIGH-LEVEL COMFORTS

For the inside, there's a choice of Standard Cloth or available Custom Vinyl upholstery for standard bench seats or available split bench seats in Club Coupe. Custom Vinyl trim is used for available bucket seats. Use of split bench or bucket seats in Club Coupes also requires use of the available folding rear seat. Full door trim panels have map pockets and soft vinyl upper trim. Color-keyed rubber floor covering also is included.

DRESS-UP OPTIONS

If you'd like to add more distinction, you can order available appearance options such as two-tone paint, Rally wheels and much more.



Sierra SLX Regular Cab interior with Standard Cloth seat trim

2-WD Sierra SLX Series C-1500 Wideside Pickup with 8-foot cargo box

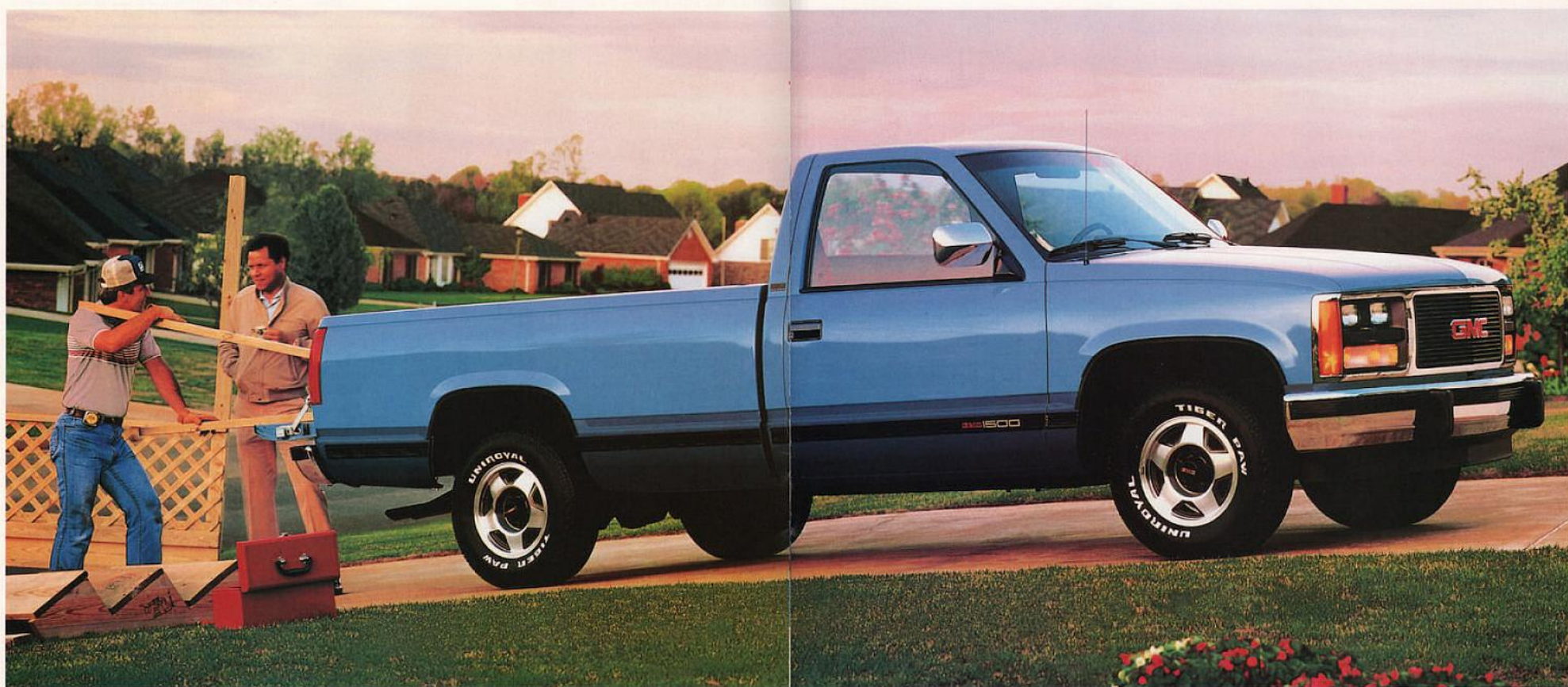

2-WD Sierra SLX Series C-1500 Wideside Pickup shown with available equipment. Tires are supplied by various manufacturers.



2-WD Sierra SL Series C-2500 Wideside Pickup with 8-foot cargo box

Sierra SL Regular Cab interior with standard Vinyl seat trim

Sierra SL

AVAILABLE REGULAR CAB AND CLUB COUPE MODELS

Uncommon standard value. When you combine the good looks of Sierra SL with its long list of features, you've got something special: A hard-working standard Pickup that stands apart from the pack.

IMPRESSIVE APPEARANCE

The smart exterior treatment includes a two-tone argent painted grille, chromed front bumper, black air dam, black outside rearview mirrors and silver-painted wheels with black hub ornaments. Wheel opening flares are included on C6P K-2500 and K-3500 4x4 models with single rear wheels.

STYLISH, PRACTICAL INTERIOR

Inside, the value begins with a foam-cushioned Vinyl or Cloth bench seat; split bench seats with the same upholstery are available for Club Coupes. Use of split bench seats in Club Coupes also requires use of the available folding rear seat. Other features include tinted glass for Club Coupes, insulated black rubber floor covering and side window defoggers.

For convenience, there's a glove box with latched door and beverage holder, a readily accessible fuse box and a handy jack-and-tool storage tray behind the front seat.



2-WD Sierra SL Regular Cab Wideside Pickup shown with available equipment

Sierra 4x4

WITH INSTA-TRAC
STANDARD ON ALL MODELS

Four-wheeling on the fly. When you want to leave the road behind you, or have to drive through mud or snow, Sierra 4x4 models deliver immediate four-wheel traction with the Insta-Trac 4-WD system.

With a quick flick of a lever, this system lets you shift the transfer case from 2 WHEEL to 4 HIGH and back without stopping, at any speed. It's a major advance over systems that require you to get out and lock or unlock hubs, or stop and reverse the truck to shift back into 2-WD.



Insta-Trac lets you shift from 2 WHEEL to 4 HIGH and back at any speed.

INDEPENDENT FRONT SUSPENSION

A torsion bar independent front suspension allows each front wheel to step over bumps and ruts independently. The result is an impressive ride even under rugged off-road conditions. This advanced suspension also provides good ground clearance, yet maintains a low vehicle height for stability and easy entry into the cab.



Available 4x4 sport graphics for Wideside models add a special dash of distinction.

BUILT 4x4 TOUGH

Rugged construction features like an all-welded frame and long-leaf rear springs help Sierra stand up to off-road punishment. Standard power steering, power brakes and anti-lock rear brake system contribute to impressive handling (anti-lock brake system operates only in the 2-WD mode). For extra-rugged 4-wheeling capability on K-1500 models, there's an available on-off road chassis package. Heavy-duty torsion bar suspen-

sion is available for use with front-mounted accessories.

NEW FOR '89

New available dual rear wheels provide K-3500 4x4 Pickup models with a 10,000-lb GVWR. That means more muscle for heavy hauling jobs, or pulling 5th wheel trailers, plus the advantage of 4-wheel drive. Also, additional payload capacity is offered in the K-2500 Series with introduction of new 8600-lb GVWR RPO C6P models.



4x4 Sierra SLE Regular Cab Wideside Pickup shown with available equipment, including snowplow and lights from outside supplier



4x4 Sierra SLE Series K-3500 Club Coupe Wideside Pickup with dual rear wheels and other available equipment



4x4 Sierra SLE Series K-1500 Regular Cab Wideside Pickup with available equipment. Tires are supplied by various manufacturers.

Cab & Chassis

Job-tough work trucks. Sierra Cab & Chassis models are designed to be outfitted with special bodies 7- to 8.5-foot long available from outside suppliers. They are available in the 25-3500 Series, with 2- or 4-wheel drive and with gasoline- or diesel-powered engines.

NEW 2500 SERIES MODELS

New for '89 are Series C/K-2500 Regular Cab and Club Coupe models rated at 8600-lb GVWR. Standard engines are the 5.7L V8 gasoline and 6.2L V8 diesel.

NEW DUAL REAR WHEEL 4X4 MODELS

For '89, dual rear wheels are available for Series K-3500 4x4 models. This gives you a Cab & Chassis with a big 10,000-lb GVWR, plus the ground-gripping traction of 4-wheel drive. Standard GVWR with single rear wheels is 8600 lb.

Series C-3500 2-WD models in the lineup also offer GVWRs of 8600 lb (with standard single rear wheels) or 10,000 lb (with available dual rear wheels).

TWO CAB STYLES

Regular Cab models, which come on a 131.5-inch wheelbase and with standard 3-person seating, are suitable

for a wide range of applications. Club Coupe models have a 155.5-inch wheelbase, and can carry a crew of six when equipped with the available 60/40 split front bench seat and available folding rear seat; without the rear seat (models with standard front bench seat), there's extra space for business tools and equipment. All models are available in the same trim levels as Sierra Pickups. Many Pickup options also are available on Cab & Chassis. See pages 18, 19 and 21. For additional information on Sierra Cab & Chassis, ask your GMC Truck Dealer for a copy of the 1989 Vans, Cab & Chassis and Forward Control Model catalog.

Power

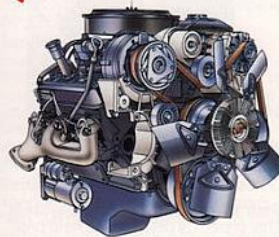

4.3L Vortec V6

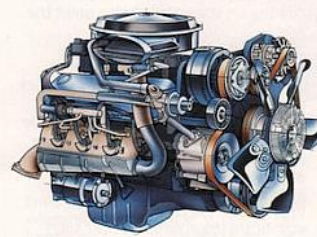

7.4L V8

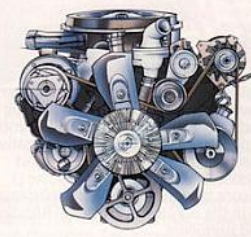

6.2L V8 Diesel

Power plus efficiency. For business jobs or pleasure trips, Sierra Pickups offer engine choices to suit the entire spectrum of performance needs. The lineup begins with the 4.3 Liter Vortec V6 — one of the most

powerful standard engines available in a half-ton pickup — and ranges all the way to a big 7.4 Liter V8 with muscle to spare for heavy hauling. And Sierra is the only full-size pickup to offer diesel power in all series (excluding other GM products). Diesel power, however, is not available on the 117.5-inch wheelbase Pickups in the C/K-1500 Series.

ELECTRONIC FUEL INJECTION

Computer-controlled Electronic Fuel Injection is standard on all gasoline engines for quick starts and smooth driveability. An on-board computer helps tune the engine as you drive.

SINGLE-BELT ACCESSORY DRIVE

All engines for Sierra have a serpen-



tine single-belt accessory drive instead of conventional multiple V-belts. It never requires adjustment and is designed for long wear.

ENGINE AVAILABILITY

For model availability of the engines noted below refer to the powertrain chart on page 22.

4.3 Liter Vortec V6. This high-compression engine features the Vortec swirl-port induction system for good mixing of fuel and air, and low-friction roller-hydraulic valve lifters for operating efficiency.

5.0 Liter V8. Swirl-port induction, fast-burn combustion chambers and coolant-heated inlet manifolds help give this popular V8 its high horsepower and torque ratings.

5.7 Liter V8. This big V8 provides all-around performance for work or play. Fast-burn combustion chambers help provide impressive acceleration.

7.4 Liter V8. A large displacement workhorse with plenty of horsepower and torque for big jobs, this proven V8 is one of the biggest engines offered in full-size pickups. It's

ideal for trailer-towing and other hard work.

6.2 Liter V8 Diesel. Designed exclusively for trucks, this rugged V8 combines heavy work capability with diesel operating advantages. Precombustion chamber cylinder head design promotes efficient fuel burning.

EFFICIENT TRANSMISSIONS

A Getrag-licensed 5-speed manual overdrive transmission is standard in all C/K-1500/2500 models (except C/K-2500 C6P models). Other transmissions in the lineup include a deep low gear 4-speed manual with power take-off provisions (standard on C/K-2500 C6P and C/K-3500 models), as well as 3-speed automatic and 4-speed automatic overdrive units. See chart on page 22 for availability.

A WORD ABOUT ENGINES

GMC Trucks are equipped with engines produced by different operating units of GM, its subsidiaries or suppliers to GM worldwide.



2-WD Sierra Series C-3500 Cab & Chassis shown with dual rear wheels and other available equipment, including stake rack body from outside supplier

Vocational bodies are supplied to GMC Truck Dealers by outside suppliers, independently of GMC Truck, which is not responsible for the safety or design features, materials or workmanship of any alteration by any such supplier.

ENGINE TECHNICAL DATA

TYPE	GASOLINE				DIESEL	
	4.3L V6	5.0L V8	5.7L V8	7.4L V8	6.2L V8	
Displacement/Configuration	4.3L V6	5.0L V8	5.7L V8	7.4L V8	6.2L V8	
Ordering Code	LB4	L03	L05	L19	LH6 (1)	LL4
Bore & Stroke, in	4.0 x 3.48	3.74 x 3.48	4.0 x 3.48	4.25 x 4.0	3.98 x 3.82	
Compression Ratio	9.3 to 1	9.3 to 1	9.3 to 1 (2)	8.6 to 1 (3)	7.9 to 1	
Fuel Delivery	electronic fuel injection				mechanical fuel injection	
SAE Net Horsepower @ RPM	160 @ 4000	175 @ 4000	210 @ 4000 (2)	190 @ 4000 (3)	230 @ 3600	126 @ 3600 (4) 140 @ 3600 (5)
SAE Net Torque (lb/ft) @ RPM	235 @ 2400	270 @ 2400	300 @ 2800 (2)	300 @ 2400 (3)	385 @ 1600	240 @ 2000 (4) 247 @ 2000 (5)

1 - Not available in California nor on short wheelbase C/K-1500 models.

2 - For models under 8500 lb GVWR.
3 - For models over 8500 lb GVWR.

4 - With manual transmission.
5 - With automatic transmission.

BUILT-IN *Quality*

Being tough isn't enough for Sierra. There's more to Sierra than the rugged strength and dependability you'd expect from a GMC Truck. Innovative design, advanced technology and precision manufacturing also help ensure that Sierra delivers solid quality in the way it works, rides, handles and performs.

Boxed front frame. Sierra's all-welded frame features a "boxed" front section for strength and rigidity. Steering gear mounted inside the frame rails provides a reduced turning circle for easy maneuvering. Power steering is standard.

Long leaf rear springs. The rear suspension includes rear springs of extended length. These are designed for durability and ride control. Teflon® coating on spring tips helps quiet the ride.

2-WD independent front suspension. Independent control arms, coil springs and big Delco shock absorbers combine to provide a smooth, balanced and controlled ride.

Advanced 4x4 suspension. Torsion bar independent front suspension allows each front wheel to work independently of the other for impressive ride control. It's a significant improvement over solid axle designs.

Insta-Trac 4x4 system. Sierra's Insta-Trac 4-WD system eliminates the need for locking hubs. It allows the driver to shift the transfer case between 2 WHEEL and 4 HIGH and back at any speed.



Rear wheel anti-lock brake control unit

Rear wheel anti-lock brake system. This system is designed to help provide smooth, stable stops, empty or loaded, on slick or dry pavements. On 4x4 models, the anti-lock system operates only in the 2-WD mode.

Rugged cargo box. Sierra's Wideside cargo box is completely welded. Ribbed cargo floors have no exposed

bolts to discolor or corrode. Tough double-wall construction is used for the sidewalls and tailgate. Similar construction is used for the Sportside cargo box.

Two-level loading. Wideside cargo box inner side panels have shelves that permit installation of stringers to support 5-foot wide cargo above the wheelhousings; 4-foot wide cargo fits between the wheelhousings. That's versatility that comes in handy on the job.

Extensive anti-corrosion measures. Special steels, primers and coatings help Sierra Pickups fight rust. To start with, all exterior body panels, except the roof, are two-side galvanized steel. In fact, galvanized steel accounts for 73% of the total sheet metal.

Aerodynamic shape. Sierra's sleek body styling slices through the air to reduce air drag. In fact, this stream-

lined design, including a 50.2-degree windshield slope angle, provides the lowest air-drag coefficient of any full-size pickup in GMC Truck history. Flush-mounted windshield and concealed drip gutters help reduce wind noise.

Easy service access. A clean, uncluttered engine compartment with neatly arranged components makes it

easy to perform routine service chores. The oil dipstick is accessible from the front. See-through plastic reservoirs permit quick checks of engine coolant, windshield washer solvent and brake fluid. Underneath the truck, a frame-mounted winch provides easy access to the spare tire (standard on 1500 Series models).

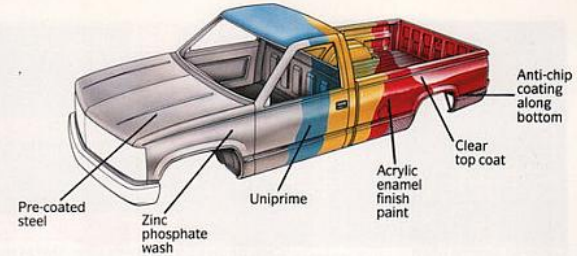

Pre-coated steel

Zinc phosphate wash

Uniprime

Acrylic enamel finish paint

Clear top coat

Anti-chip coating along bottom

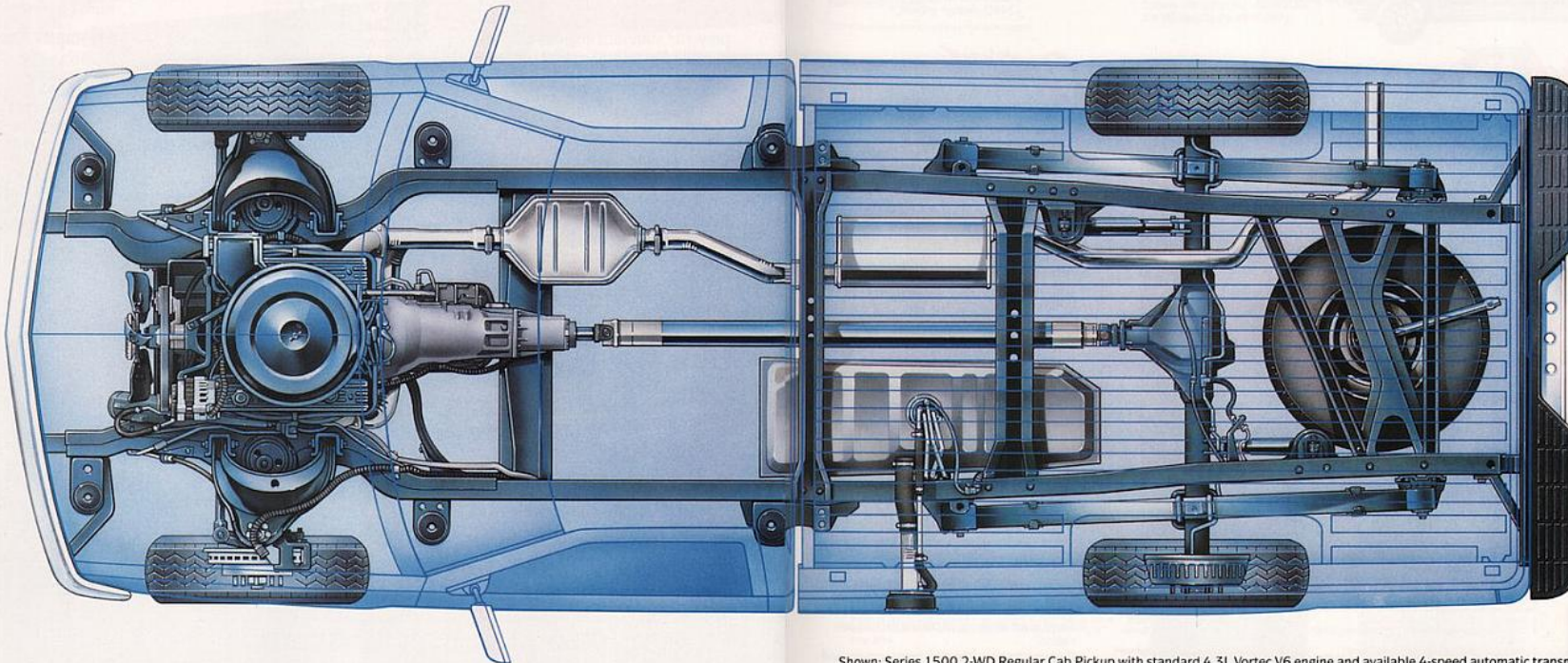

Shown: Series 1500 2-WD Regular Cab Pickup with standard 4.3L Vortec V6 engine and available 4-speed automatic transmission with overdrive

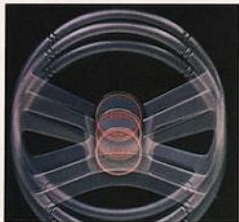

Comfortilt steering wheel



Cassette deck (included with some AM/FM stereo radios)



Delco AM/FM stereo radio (at top)



Operating convenience package (power windows and power door locks)



Below eyeline mirrors



Rear step bumper and platform trailer hitch



Front bumper guards



Sliding rear window and cargo lamp



Aluminum wheels (2-WD design shown)*



Full wheel covers*

*Tires are supplied by various manufacturers.

Value Packages

Buy a 1989 Sierra Regular Cab or Club Coupe Pickup with an available Value Package and save! Regular Cab packages shown. Savings based on Manufacturer's Suggested Retail Price for Value Package versus options purchased separately. Ask your Light Duty GMC Truck Dealer for discount details.

ORDERING INSTRUCTIONS:

□ You may add options to these packages; however, NO DELETIONS ARE ALLOWED WITHOUT THE LOSS OF DISCOUNT.

□ Allowable upgrades:

- A) To Rally Wheels or Cast Aluminum Wheels on Series 1500 4-WD models and to Styled Wheels, Rally Wheels or Cast Aluminum Wheels on Series 1500 2-WD models.
- B) To Rally Wheels on Series 25-3500 models.
- C) To any other available stereo radio.
- D) To Air Conditioning (H) Heater included in Cold Climate Package.
- E) To Stainless Steel Below Eyeline/Camper Mirrors.
- F) To Rear Window Defogger.
- G) To Off Road Chassis Package (H) Shocks included in CK 10903 models with Trailering Special Equipment.
- H) To AM Stereo FM Stereo with Seek-Scan, Cassette Tape, Equalizer & Digital Clock.
- I) To Cast Aluminum or Styled Wheels on Series 1500 2-WD models and to Cast Aluminum Wheels on Series 1500 4-WD models.

	PACKAGE 1 2WD	4WD	PACKAGE 2 2WD	4WD
SL Value Package Engine: 4.3L V6 (1) Headliner Package	•	•	•	•
Wheel Covers (A) (B) Radio: AM/FM Stereo with Seek-Scan & Digital Clock (C)	•	•	•	•
Gauges: Voltmeter, Temperature & Oil Pressure Lighter: Cigarette Heater: Heavy-Duty (D) Mirrors: Below Eyeline, Painted (E) Window: Sliding Rear (F)	•	•	•	•
Tank: 34-Gallon (approx.) Fuel (2) Windshield Wiper System: Intermittent Body: Wideside (3)	•	•	•	•
Stabilizer Bar: Front (4) Shock Absorbers: Front & Rear, Heavy-Duty (Series 1500 only) (C)	•	•	•	•
Battery: Heavy-Duty (Series 15-2500 only) (5) Lighting: Auxiliary Glass: Tinted, All Windows Wheels: Single Rear (Series 3500 only)	•	•	•	•
SLX Value Package Sierra SLX Trim Appearance: Deluxe Front	•	•	•	•
Radio: AM/FM Stereo with Seek-Scan, Cassette Tape & Digital Clock (H) Wheels: Rally (Wheel Trim Rings substituted on Series 3500 with Dual Rear Wheels) (I)	•	•	•	•

- 1 - Required
- 2 - Upgrade not permitted. Includes 5.7L V8 engine on CK C6P models.
- 3 - Sports side body may be substituted on CK 10703 models.
- 4 - Included when upgrading to Off Road Chassis Package on CK 1500 models or Camper Special Equipment on CK 2500/3500 models.
- 5 - Not available nor required with Diesel equipment.

Options

Personalize your Sierra. For added appearance, comfort and performance, you can equip your Sierra with a variety of available options, some of which are depicted on this page. For additional information, see page 21. Note: Some items are standard on some Sierra models. Ask your GMC Truck Dealer for complete information.

Available appearance equipment includes:

- SLX and SLE interior/exterior trim packages
- Deluxe front appearance package
- Body side moldings
- Wheel opening moldings
- Two-tone paint schemes/4x4 graphics
- Rally wheels
- Bright wheel trim covers
- Black front bumper guards.

Available comfort and convenience equipment includes:

- Air conditioning
- AM radio
- Electronically tuned AM/FM stereo radio with seek-scan
- Electronically tuned AM/FM stereo radio with seek-scan and digital clock
- Electronically tuned AM/FM stereo radio with seek-scan and stereo cassette tape
- Electronically tuned AM/FM stereo radio with seek-scan, stereo cassette tape and digital clock
- Electronically tuned AM stereo/FM stereo radio with seek-scan, stereo cassette tape, graphic equalizer and digital clock
- Fixed mast antenna (included with above radios)
- Cage package: voltmeter, temperature and oil pressure gauges

- Electronic speed control
- Intermittent windshield wipers
- Sliding rear window
- Cargo area lamp
- Rear window defogger
- Operating convenience package (power door locks and power windows)
- Halogen headlamps (included with Deluxe Front Appearance Package)
- Roof marker lamps.

Available chassis equipment includes:

- Locking rear differential
- 4x4 stone shield plate package
- Heavy-duty shock absorbers
- Engine oil cooler
- Engine block heater
- Front tow hooks
- Single 34-gallon fuel tank
- Dual rear wheels
- Heavy-duty torsion bars
- Auxiliary lighting package.

Trailering Special Equipment (ZB2): A factory-installed package designed to permit towing gross trailer weights up to 10,000 lb (includes trailer, cargo and equipment on trailer). The package consists of the following components: Wiring harness, weight-distributing platform hitch and heavy-duty radiator and transmission oil cooler combination. See back cover for additional trailering information.

F. Receives C-QUAM[®] AM stereo broadcasts. Most AM stereo stations across the country broadcast in C-QUAM but some do not. Check with your local stations for compatibility in your area.

Paint Schemes

Available Conventional Two-Tone places accent color below the lower styling feature line. Available for all models.

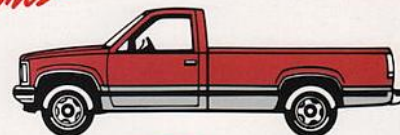

Available Special Two-Tone includes a multi-stripe decal at the upper styling feature line, with the accent color below the striping. Available for Wideside models only.

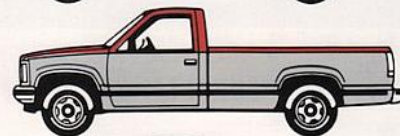

Available Deluxe Two-Tone includes a multi-stripe decal at the upper styling feature line. Accent color is applied between the striping and the lower feature line. Available for Wideside models only.

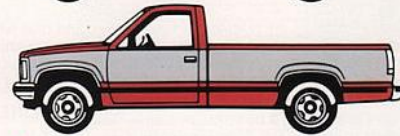

Exterior Colors

Note: Due to printing irregularities, colors shown may vary from actual tones. Ask your GMC Truck Dealer to show you actual color chips. (M) = Metallic



Smoke Blue (M)



Sable Black (M)

Summit White

Adobe Gold (M)



Sandstone (M)



Caramel Brown (M)



Flame Red



Brandywine (M)



Quicksilver (M)



Midnight Blue (M)



2-WD Sierra SL Series 2500 Wideside Pickup shown with available equipment

BUSINESSMEN LIKE

Sierra

During the day, it's a hard-working vehicle for any job you have to do, from hauling cargo to pulling trailers or making service calls...

Sierra is a rugged, reliable pickup that offers everything a business owner needs to get the job done efficiently and economically.

FULL-SIZE VERSATILITY

Because it's a full-size pickup, Sierra offers strength and hauling capacity you can't get with mid-size and compact pickups. That means lots of muscle for jobs like moving heavy cargo or towing trailers.

TRUCK-TOUGH DURABILITY

From rugged body-on-frame construction to extensive anti-corrosion measures, Sierra is built to go the distance in commercial service, day in and day out.

POWER TO DO THE JOB

Sierra offers engine choices to fit job requirements, including the 4.3 Liter Vortec V6, one of the most powerful standard engines available in a 1/2-ton pickup. Also in the power lineup are three big V8s and a truck-proven diesel V8. All gasoline engines have Electronic Fuel Injection for quick starts in hot or cold weather.

BIG ON STANDARD VALUE

Sierra's long list of standard features includes power steering, power brakes

and rear wheel anti-lock braking. A smooth-shifting 4- or 5-speed manual transmission also is standard, depending on the model.

FULL-LINE SELECTION

Name your application and there's a Sierra model to do the job. They come in Regular Cab or Club Coupe versions in the 15-25-3500 Series; with 2- or 4-wheel drive; with choice of gasoline or diesel power in most applications; with 6.5- or 8-foot Wideside cargo boxes, or 6.5-foot Sportside cargo box. There are also hard-working Cab & Chassis models that can be adapted for special jobs with available bodies and vocational equipment from outside suppliers.

BIG PAYLOAD CAPACITIES

Sierra's got the muscle to move a hefty load on every trip. Payload capacities range up to a whopping 5255 lb for a gasoline-powered, long wheelbase C-3500 Regular Cab Pickup with dual rear wheels and other available equipment (payload includes occupants, cargo and all equipment).

SPACIOUS CARGO BOXES

Unlike smaller pickups, Sierra's roomy cargo boxes let you stack 4-foot wide building materials flat on the floor — between the wheelhousings on Wideside models, or between the sidewalls of the Sportside. And, thanks to a

special sidewall design feature, Wideside models also can carry 5-foot wide materials above the wheelhousings.

After work and on weekends, it's a practical vehicle for family transportation, vacations and outdoor recreation...

Sierra is a vehicle that can fit your lifestyle as well as your work style. With its spacious interior and quiet, comfortable ride, it easily makes the switch from business truck to an everyday vehicle that can take you where you want to go with plenty of style.

SPACE FOR A FAMILY

You can have standard three-across seating or accommodate a family of six in a Club Coupe with available front and rear seating. Front bucket seats also are available. And Sierra's 6.5- or 8-foot cargo boxes tote big loads for pleasure trips.

DISTINCTIVE STYLING

Sierra stands out from ordinary pickups with its sleek exterior styling and tasteful interior appointments. It's a truck that looks good anywhere you take it.

A PLEASURE TO DRIVE

Sierra's advanced front suspension system and other improvements provide a smooth, quiet ride that makes it a pleasure to drive for work or play. Plus, it's surprisingly easy to park and handle.

STANDARD AND AVAILABLE EQUIPMENT

TRIM LEVEL		SIERRA SL (STD)	SIERRA SLX (Z62)	SIERRA SLE (YE9)
EXTERIOR APPEARANCE EQUIPMENT				
FLARES, WHEEL OPENING (K-5500 AND C&P K-2500 MODELS)		S	S	S
MOLDINGS (SINGLE REAR WHEEL PICKUPS)	Black body side	A	S	—
	Black wheel opening	A 1, 2	S 2	—
	Bright-trimmed black body side	—	A 3, 4	S
	Bright wheel opening	—	A 2, 5	S 2
RADIATOR GRILLES	Light/dark argent paint finish	S	S	—
	Chromed finish with light/dark argent paint trim	—	A	S
	Chromed finish with light/dark argent paint trim	A	A	S
WHEELS/WHEEL TRIM	Silver painted conventional wheels with black hub ornament	S	S	—
	Silver painted styled wheels with black hub ornament (Series C-1500 only)	A	A	A
	Aluminum wheels with 4x4 identification (K-1500 Regular Cab only)	A	A	A
	Aluminum wheels with black hub ornament (Series C-1500 only)	A	A	A
	Rally wheels (standard wheels and bright hub ornament plus bright trim rings) (C/K-1500/2500 only)	A	A	A
	Bright wheel trim covers (single rear wheels only)	A	A	A
	Bright wheel trim rings (C/K-3500 with dual rear wheels)	A	A	A
	Dual rear wheels (C/K-3500 only)	A	A	A
INTERIOR APPEARANCE EQUIPMENT				
FLOOR COVERINGS	Black rubber with insulator (partial on Regular Cab)	S	—	—
	Full-length color-keyed rubber with insulator	—	S	—
	Full-length color-keyed carpeting with insulator	—	—	S
HEADLINER	Full-length; insulated	S	S	S
COMFORT/CONVENIENCE/PROTECTION EQUIPMENT				
AIR DEFLECTOR	Mounted to underside of front bumper	S	S	S
ASSIST HANDLE	Above RH door (4-WD only)	S	S	S
BUMPERS, FRONT	Chromed without rub strip	S	—	—
	Chromed with bright-trimmed rub strip	A	S	S
BUMPERS, REAR (STEP-TYPE)	Black painted	A 6	A 6	—
	Chromed with plain rub strip	A 7	A	A
COAT HOOKS, LHRH		S 8	S	S
FLOOR MATS	Front floor	—	—	A
	Front and rear floor (Club Coupe with rear seat only)	—	—	A
GLASS (CLUB COUPE)	Tinted glass all-around	S	S	S
	Deep-tinted swing-out quarter window glass	A	A	A
	Deep-tinted swing-out quarter and fixed rear window glass	A	A	A
GLASS (REGULAR CAB)	Clear glass all-around	S	S	S
	Tinted glass all-around	A	A	A
GUARDS, FRONT BUMPER	Black painted with black impact pad (requires rub strip type front bumper)	A	A	A
HEATING/COOLING	Outside air type heater with windshield and side window defoggers	S	S	S
	Heavy-duty heater to replace standard heater	A	A	A
	Outside air type heater-air conditioner ¹	A	A	A
	Cold climate package for gasoline engine models	A	A	A
	Electric rear window defogger	—	A	A
HORN	Single low-note	S	—	—
	Dual high/low-note	—	S	S
INSTRUMENT PANEL (MISCELLANEOUS)	Glove box with latched door and beverage holder provisions	S	S	S
	Integral fuse block with access door	S	S	S
	Tip-out ashtray	S	S	S
	Cigarette lighter (in ashtray)	A	A	A
	Pencil tray at center	S	S	S
JACK AND TOOL STORAGE	In tray behind front seat or on rear compartment floor	S	S	S

S - Standard

A - Available

1 - Requires black body side moldings.

2 - Except K-3500 Series or Sportside Pickup.

3 - Requires bright wheel opening moldings.

4 - Not available with painted rear bumper.

5 - Requires bright-trimmed body side moldings.

6 - Not available on Sportside Pickup.

7 - Requires chromed front bumper with rub strip.

8 - Right hand only on Regular Cab models.

9 - Also available as part of optional deluxe front appearance package.

10 - Not available in California on single rear wheel models; included with available dual rear wheels.

11 - Available only as part of optional auxiliary lighting package.

12 - Also available as part of optional auxiliary lighting package.

13 - Requires available loading rear seat.

14 - See your GMC Truck Dealer for details.

TRIM LEVEL		SIERRA SL (STD)	SIERRA SLX (Z62)	SIERRA SLE (YE9)
COMFORT/CONVENIENCE/PROTECTION EQUIPMENT (cont'd)				
LAMPS, EXTERIOR	Halo ring headlamps	A 9	A 9	S
	Roof marker lamps (25-3500 Series) (single rear wheels) (not available in California)	A	A	A
	Cargo area lamp	A	A	A
	Underhood lamps (both fixed and reel-type)	A 11	A 11	A 11
	Headlamp warning buzzer	A 11	A 11	A 11
LIGHTING, INTERIOR	Dome lamp	S	S	S
	Dome/reading lamp	A 12	A 12	A 12
	Courtesy lamp, LHRH (on instrument panel lower lip)	A 11	A 11	A 11
	Ashtray lamp	A 11	A 11	A 11
	Glove box lamp	A 11	A 11	A 11
	Dome (for dome and courtesy) lamp door-operated switch, LH	S	S	S
	Dome (for dome and courtesy) lamp door-operated switch, RH	A 11	A 11	A 11
LOCK	Fuel filler cap	A	A	A
MIRRORS, DUAL REARVIEW EXTERIOR	Black painted below eyeline type with swingaway feature	A	A	A
	Black painted conventional type	S	S	S
	Stainless steel below eyeline type with swingaway feature	A	A	A
	Stainless steel camper type	A	A	A
MIRRORS, INTERIOR	Non-glare rearview	S	S	S
	RH sunshade (vanity)	—	—	S
POWER EQUIPMENT	Operating convenience package (power door locks and windows)	A	A	A
RADIOS	Various (14)	A	A	A
SEATS/SEAT TRIM (CLUB COUPE)	Vinyl bench seat	S	—	—
	Vinyl split seat	A 13	—	—
	Cloth bench seat	A	S	—
	Cloth split bench seat	A 13	A 13	—
	Custom cloth split bench seat	—	—	A 13
	Custom cloth bucket seats	—	—	A 13
	Custom vinyl split bench seat	—	A 13	A 13
	Custom vinyl bucket seats	—	A 13	A 13
	Custom vinyl bench seat	—	—	A 13
SEATS/SEAT TRIM (REGULAR CAB)	Vinyl bench seat	S	—	—
	Cloth bench seat	A	S	—
	Custom cloth bench seat	—	—	S
	Custom cloth bucket seats	—	—	A
	Custom vinyl bucket seats	—	—	A
	Custom vinyl bench seat	—	—	A 14
SHIELDS/SHIELD PLATES	Bathtub-type fuel tank shields	S	S	S
	4-WD shield plate package	A	A	A
SPARE WHEEL/TIRE CARRIER	Winch-type at rear of vehicle (Requires spare tire and wheel)	S	S	S
	Side-mounted inside Wideside Pickup box on LH side (single rear wheel models)	A	A	A
SPEED CONTROL	Electronic type	A	A	A
STEERING COLUMN/WHEEL	Energy-absorbing column (black)	S	S	S
	Standard 4-spoke energy-absorbing wheel (black)	S	S	S
	Custom 4-spoke energy-absorbing wheel (black)	A	A	S
	Sport 4-spoke energy-absorbing wheel (black)	—	—	A
	Comfort/tilt steering wheel (black)	A	A	A
STORAGE CONSOLE, FLOOR-MOUNTED	For use between available front bucket seats	—	—	A
SUNSHADES	Vinyl-covered, LHRH	S	S	—
	Cloth-covered with storage strap, LH	—	—	S
	Cloth-covered with vanity mirror, RH	—	—	S
TOW HOOKS, FRONT	LHRH frame-mounted	A	A	A
VENTILATION, FLOW-THROUGH		S	S	S
WINDSHIELD WIPER/WASHER	Two-speed wipers/demand-type washer with dual fluidic spray nozzles	S	S	S
	Two-speed wipers with intermittent feature/demand-type washer with dual fluidic spray nozzles	A	A	A

OTHER EQUIPMENT (see your GMC Truck Dealer for details)

TECHNICAL INFORMATION

PICKUP MODEL SERIES	2-WD C-1500	4-WD K-1500	2-WD C-2500	4-WD K-2500	2-WD C-3500 (SR)	4-WD K-3500 (SR)	2-WD C-3500 (DR)	4-WD K-3500 (DR)
GVW RATING, lb	Regular Cab	5600 (1) 6100 (2)	5600 (1) 6100 (2)	7200/8600	7200/8600	8600 (1)	8600 (1)	10,000
	Club Coupe	6200	6200(1)/6600	7200/8600	7200/8600	8600 (1)	8600 (1)	10,000
FRONT SUSPENSION								
independent, coil springs (2-WD)/torsion bars (4-WD)								
Capacity, lb	Regular Cab	2950 (3)	3350 (4)	3150 (5)	3925 (11)	3800	4250	3800
	Club Coupe	3600	3925	3600 (7)	3925 (11)	3800	4250	3800
Spring/torsion bar capacity, lb (6)	Regular Cab	1475-1800	1800-1962.5	1575-1900 (8)	1875-1962.5 (15)	1800-1900	1875-2125	1800-1900
	Club Coupe	1750-1800	1800-1962.5	1800-1900	1875-1962.5 (15)	1800-1900	1875-2125	1800-1900
Shock absorber diameter, in	Standard	1.00	1.00	1.26	1.26	1.26	1.26	1.26
	Optional	1.26	1.26	—	—	—	—	—
Stabilizer bar diameter, in	Optional	1.00	1.00	1.00	1.00	1.00	1.00	1.00
REAR SUSPENSION								
Salisbury axle with leaf springs								
Axle capacity, lb		3750	3750 (13)	4800 (9)	4800 (9)	6000	6000	7500
Spring capacity, lb (6)		1875	1875	2400 (10)	2400 (10)	3000	3000	3750
Shock absorber diameter, in	Standard	1.00	1.00	1.26	1.26	1.26	1.26	1.26
	Optional	1.26	1.26	—	—	—	—	—
SERVICE BRAKES								
power-assisted hydraulic front disc/rear drum with rear anti-lock system								
Power assist type	Gasoline models	vac	vac	vac	vac	vac	hyd.	hyd.
	Diesel models	hyd.	hyd.	hyd.	—	—	hyd.	hyd.
PARKING BRAKES								
variable ratio, power-assisted cable to rear wheels								
STEERING								
(all standard tires are All Seasons radial-ply type)								
TIRES	Standard (Regular Cab)	P225/75R15	LT225/75R16C	LT225/75R16D (14)	LT225/75R16D	LT245/75R16E	LT245/75R16E	LT225/75R16C/D
	Standard (Club Coupe)	P235/75R15	LT245/75R16C	LT225/75R16D (14)	LT245/75R16C	LT245/75R16E	LT245/75R16E	LT225/75R16C/D
	Optional	—	—	—	—	—	—	—
various types and sizes (12)								
FUEL TANK NOMINAL CAPACITY, gallons	Standard	25						
	Optional	34						
BATTERY								
12-volt, Delco Freedom II + type								
CCA rating (gasoline models)	Standard	430 (5.0L V8 & manual transmission); 525 (4.3L V6/5.0L V8 & automatic transmission/5.7L V8); 630 (7.4L V8)						
	Optional heavy-duty	630	630	630	630	630	630	630
	Optional auxiliary	540	540	540	540	540	540	540
CCA rating (diesel models)	Standard (dual)	570	570	570	570	—	570	570
DELCOTRON GENERATOR AMP RATING								
85 (100-amp with optional air conditioning)								

- SR - Single rear wheels DR - Dual rear wheels 2-WD - 2-wheel drive 4-WD - 4-wheel drive CCA - Cold Cranking Amps
 1 - Not available for diesel models. 2 - Not available for short wheelbase models. 3 - 3150 lb for diesel models or 6100 lb for GM gasoline models. 4 - Short wheelbase models (5450 lb for long wheelbase models). 3925 lb for diesel models or 6100 lb for GM gasoline models. 5 - For 7200 lb GVW gasoline models (5400 lb for diesel models). 3800 lb for 8600 lb GVW models (C6P). 6 - At ground, each.
 7 - For 7200 lb GVW models; 5800 lb for 8600 lb GVW models (C6P). 8 - For 7200 lb GVW gasoline models (1100-1900 lb for diesel models); 1800-1900 lb for 8600 lb GVW models (C6P). 9 - For 7200 lb GVW models; 6000 lb for 8600 lb GVW models (C6P). 10 - For 7200 lb GVW models; 3000 lb for 8600 lb GVW models (C6P). 11 - For 7200 lb GVW models; 4250 lb for 8600 lb GVW models (C6P). 12 - Tire chains should not be used on K-1500 models with available LT265/75R16 tires or on C/K-3500 models with available dual rear wheels as they may cause damage to the vehicle. 13 - 4807 lb for Club Coupe diesel models or 6600 lb for Club Coupe models. 14 - LT245/75R16E for 8600-lb GVW models. 15 - For 7200 lb GVW models; 1875-2125 lb for 8600 lb GVW models.

PICKUP POWERTRAINS

ENGINE	ENGINE AVAILABILITY BY MODEL	TRANSMISSIONS				REAR AXLE RATIOS (1)	
		MANUAL	5-SPD OD (MMS)	3-SPD (MX1)	4-SPD OD (MX0)	STD	AVAILABLE
4.3L V6 GAS (LB4)	TC107-10903/53	A 2	S	—	A	3.08	3.42
	TK107-10903/53	—	S	—	A	3.42	3.73 (6) (8)
	TC/K20753 TC/TK20903-53 (C6P)	A	S	—	A	3.42	3.73 (6)
5.0L V8 GAS (L03)	TC107-10903/53	—	S 3	—	A	3.08	3.42
	TK107-10903/53	—	S 3	—	A	3.42	3.73
	TC/K20753 TC/TK20903-53 (C6P)	—	A 3	—	A	3.42	3.73
5.7L V8 GAS (L05)	TC10703-10903/53	A 2,3	S 3	—	A	3.08	3.42
	TK107-10903/53	A 3	S 3	—	A	3.42	3.73 (6) (8)
	TC/K20753 TC/TK20903-53 (C6P)	A 3	S 3	—	A	3.42	3.73 (6)
7.4L V8 GAS (L19)	TC10703-10903/53	—	S 3	—	A	3.42	3.73 (6)/4.10 (6)
	TK107-10903/53	—	S 3	—	A	3.42	4.56 (6)
	TC/TK20903-53 (DR)	—	S 3	—	A	3.42	3.73/4.10 (6)
6.2L V8 DIESEL (LH6/L14)	TC/TK10753 TC/TK10903-53	—	—	—	A	3.75	4.10 (6)/4.56 (6)
	TC/TK20753 TC/TK20903-53 (C6P)	S 3,4	—	—	A	3.08	3.42
	TC/TK20903-53 (6C6P)	S 5	—	—	A	3.42	3.73
	TK30903-53 (DR)	S 5	—	—	A	3.73	4.10

- S - Standard A - Available SR - Single rear wheels DR - Dual rear wheels OD - Overdrive
 1 - For standard transmission at standard GVW. Consult your GMC Truck Dealer for other axle ratio applications, including High Altitude Emissions (HAE). 2 - Not available on Models TC10703/53. 3 - Except California. 4 - LH6 light-duty emission engine. 5 - LH6 heavy-duty emission engine. 6 - Requires KC4 engine oil cooler. 7 - Requires V02 cooling. 8 - Requires V02 cooling with MNO/MX1 transmission.



DIMENSIONAL DATA

Note: All dimensions shown in inches.

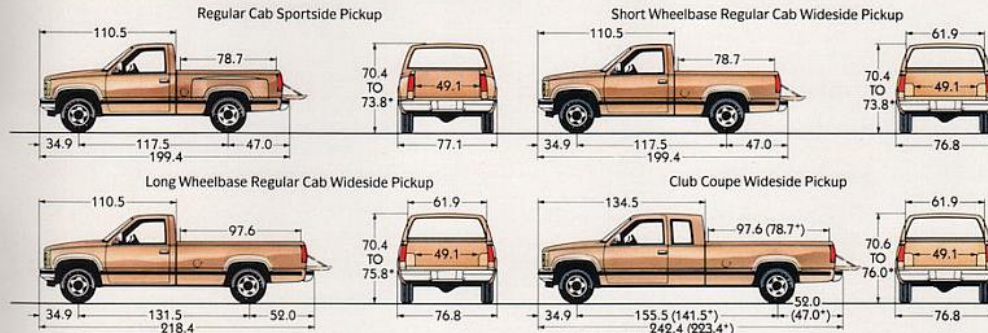

*Short Wheelbase Models
 * At curb weight. See your dealer for particulars.
 + Short wheelbase models.

SIERRA PICKUP AND CAB & CHASSIS MODEL AVAILABILITY

ENGINE TYPE	GASOLINE				DIESEL			
	WIDESIDE PICKUP		SPORTSIDE PICKUP		CAB & CHASSIS		CAB & CHASSIS	
MODEL TYPE	REGULAR	CLUB COUPE	REGULAR	CLUB COUPE	REGULAR	CLUB COUPE	REGULAR	CLUB COUPE
CAB TYPE	REGULAR	CLUB COUPE	REGULAR	CLUB COUPE	REGULAR	CLUB COUPE	REGULAR	CLUB COUPE
Wheelbase, in	117.5	131.5	141.5	155.5	117.5	131.5	141.5	155.5
Box Length, ft	6.5	8.0	6.5	8.0	6.5	8.0	6.5	8.0
2-WHEEL DRIVE MODEL SERIES								
C-1500	X	X	X	X	—	—	X (1)	X (1)
C-2500	—	—	X	X	—	—	X	X
C-2500 & C6P	—	—	X	X	—	—	X	X
C-3500	—	X (2)	—	X (2)	—	—	X (2)	X (2)
4-WHEEL DRIVE MODEL SERIES								
K-1500	X	X	X	X	—	—	X (1)	X (1)
K-2500	—	X	X	X	—	—	X	X
K-2500 & C6P	—	X	X	X	—	—	X	X
K-3500	—	X (2)	—	X (2)	—	—	X (2)	X (2)

1 - Not available in California. 2 - Available with dual rear wheels.

IMPORTANT: A WORD ABOUT THIS CATALOG. We have tried to make this catalog as comprehensive and factual as possible. We reserve the right, however, to make changes at any time, without notice, in prices, colors, materials, equipment, specifications, models and availability. Since some information may have been updated since the time of printing, please check with your GMC Truck Dealer for complete details.
A WORD ABOUT ASSEMBLY OF GMC TRUCKS. GMC Trucks are assembled by different operating units of General Motors, its subsidiaries or suppliers to GM worldwide. We sometimes find it necessary to produce GMC Trucks with different or differently sourced components than originally scheduled. All such components have been approved for use in GMC Trucks and will provide the quality performance associated with the

GMC Truck name. Since some options may be unavailable when your vehicle is assembled, we suggest you verify that your vehicle includes the equipment you ordered or, if there are changes, that they are acceptable to you.
 These vehicles are also available under the Chevrolet nameplate as Series C/K 1500-2500-3500 Cheyenne, Scottsdale and Silverado Pickups.
A WORD ABOUT UPDATED SERVICE INFORMATION. GMC Truck Division regularly sends its dealers useful service bulletins about GMC Truck products. GMC Truck Division monitors product performance in the field. We then prepare bulletins for servicing our products better. Now you can get these bulletins, too. Ask your dealer. To get ordering information, call toll free 1-800-551-4123.

Trailer

Big muscle for trailering. A properly equipped Sierra is a powerful towing vehicle. Check the chart below for maximum allowable Gross Combination Weight Ratings (GCWR) based on standard and available engines and rear axle ratios for Sierra with an available automatic transmission.

Sierra can be ordered with available trailering packages that help equip it for towing. See the '89 GMC Truck Trailering Guide for complete details about trailering recommendations and requirements.



4x4 Sierra SLE Series 1500 Wideside Pickup. Tires are supplied by various manufacturers.

GROSS COMBINATION WEIGHT RATING FOR TRAILERING WITH AUTOMATIC TRANSMISSIONS

ENGINE	GROSS COMBINATION WEIGHT RATING, (lb)*														
	7500	8500	9000	9500	10,000	10,500	11,000	11,500	12,000	12,500	13,500	14,500	15,000	16,000	19,000
	REAR AXLE RATIO														
4.3L V6 GAS (LB4)	2.73	3.08	—	3.42	3.73	4.10	—	—	—	—	—	—	—	—	—
5.0L V8 GAS (L03)	—	2.73	—	3.08	—	3.42	—	3.73	—	4.10	—	—	—	—	—
5.7L V8 GAS (L05)	—	—	2.73	—	3.08	—	3.42	—	3.73	—	4.10	—	4.56	—	—
7.4L V8 GAS (L19)	—	—	—	—	—	—	—	—	—	—	3.42	3.73	—	4.10	4.56
6.2L V8 DIESEL (LH6/LL4)	—	—	—	—	3.42	—	3.73	—	4.10	—	4.56	—	—	—	—

* Includes weight of truck, trailer, passengers, cargo and equipment on truck and trailer.

Owner Benefits

LOW MAINTENANCE

The technology that goes into Sierra has contributed in many ways to reducing the time and effort required for routine service and maintenance. Consider these advanced features:

- Delco Freedom II+ battery never needs refilling with water; has built-in test hydrometer
- Integral voltage regulator is built into Delco-tron generator; it's transistorized for reliability
- Starter solenoid is integral; provides positive starter engagement
- Large fuse block has tweezer-type fuse removal for easy serviceability
- Mufflers have heavy-gauge outer shell and are aluminized inside and out for added durability
- Engine coolant recovery reservoir collects hot overflow coolant and returns it to radiator automatically when it cools
- Self-adjusting hydraulic clutch with manual transmissions
- Tires have built-in tread wear indicators
- See-through reservoirs for quick checks of engine coolant, windshield washer fluid and brake fluid
- No adjustments for idle speed or fuel-air mixture on gasoline engines — an on-board computer helps tune the engine as you drive
- Audible wear sensors on front disc brakes for early warning of brake pad wear
- Front and rear brake designs include a self-adjusting feature
- Single-belt engine accessory drive with automatic belt tensioner never needs adjustment.

Shown below are a few of the recommended maintenance intervals for Sierra models with light-duty emission gasoline engines.

- Change engine oil & filter every 7500 miles*
- Replace air filter every 30,000 miles*
- Change spark plugs every 30,000 miles*
- Replace engine coolant . . . every 30,000 miles or 24 months*

* More often under certain conditions. See your Maintenance Schedule booklet.

DEALER SERVICE



Commitment Plus is one of the most complete joint sales and service customer satisfaction programs available on light-duty trucks today. It offers the following benefits:

- A thorough pre-delivery vehicle inspection
- One full tank of fuel
- Complimentary 3000-mile maintenance service including oil change and oil filter.

GMC Truck and GMC Truck Dealerships are truly committed to making GMC Light Duty Trucks easy to live with. Our customers' total satisfaction is indeed our goal!

Commitment Plus applies to retail sales only, but not to any Series C/K-3500 model described in this catalog.

When your new Sierra needs service, you can count on the professionals at any of GMC Truck's approximately 2500 Light Duty Truck Dealerships.



GM-CAMS is now installed at over 400 GMC Truck participating dealerships. GM-CAMS is an abbreviation for the Computerized Automotive Maintenance System. It is designed to diagnose conditions related to electronic system and powertrain driveability problems plus Sierra anti-lock rear brakes. GM-CAMS is not a replacement for other diagnostic tools, such as those used to diagnose traditional mechanical functions. CAMS' main function is to isolate malfunctions in electronic systems controlled by the vehicles' on-board computers. In addition, GM-CAMS permits access to a storehouse of information frequently used by technicians for routine repair, other than electronics.

FINANCING & LEASING GMAC

When it comes to financing or leasing a new GM vehicle, General Motors Acceptance Corporation can make things easy. With GMAC, the entire transaction is handled right in the dealer's showroom. Rates are competitive, and terms are tailored to fit your circumstances.

For many people, leasing a new truck through GMAC is an ideal way to suit their transportation needs. Ask your GMC Truck Dealer for details.



Quality Network

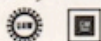

GMC®, Chevrolet®, Insta-Trac® and Delco® are registered trademarks of General Motors Corporation.
© General Motors Corporation 1988. All Rights Reserved.
2619-89 USA Litho in USA